

# E-SG

- Termosigillatrici elettriche
- Electrical thermosealing machines
- Thermoscelleuses électriques
- Elektrische Thermoschweißgeräte
- Termoselladoras neumáticas



**VALKO**<sup>®</sup>



Vacuum packaging technology

Made in Italy

# E-SG

Mod.

## E-SG 260



### CARATTERISTICHE

- Termosigillatrice semiautomatica elettrica
- Costruita in acciaio inox
- Piastra in alluminio teflonata
- Controllo elettronico della temperatura della piastra (0-200°C)
- Ciclo di saldatura automatico
- Facile e rapida sostituzione della piastra saldante

### CHARACTERISTICS

- Semiautomatic electrical thermosealing machine
- Built in stainless steel
- Teflon coated aluminium plate
- Electronic control of the plate temperature (0-200°C)
- Automatic sealing cycle
- Easy and rapid change of the sealing plate

### CARACTERISTIQUES

- Thermoscelleuse semi-automatique électrique
- Construite en acier inox
- Plaque en aluminium teflonée
- Contrôle électronique de la température de la plaque (0-200°C)
- Cycle de soudure automatique
- Changement de la plaque de chauffe facile et rapide

Mod.

## E-SG 420



### MERKMALE

- Halbautomatisches und elektrisches Thermo-Schweißgerät
- Aus Edelstahl gebaut
- Platte aus Teflon-beschichtetem Aluminium
- Elektronische Temperaturregelung der Platte (0-200° C)
- Automatischer Schweiß-Zyklus
- Leichter und schneller Austausch der Schweißplatte

### CARACTERÍSTICAS

- Termoselladora semiautomática eléctrica
- Construida en acero inox
- Plancha de aluminio teflonada
- Control electrónico de la temperatura de la plancha (0-200°C)
- Ciclo de soldadura automático
- Sustitución fácil y rápida de la plancha soldadora

Mod.

## E-SG 260 GF



### CARATTERISTICHE

- Termosigillatrice semiautomatica elettrica
- Costruita in acciaio inox
- Piastra in alluminio teflonata
- Controllo elettronico della temperatura della piastra (0-200°C)
- Ciclo di saldatura automatico
- Facile e rapida sostituzione della piastra saldante
- Dotata di sistema "gas flushing" (non è possibile utilizzare la piastra saldante universale)

### CHARACTERISTICS

- Semiautomatic electrical thermosealing machine
- Built in stainless steel
- Teflon coated aluminium plate
- Electronic control of the plate temperature (0-200°C)
- Automatic sealing cycle
- Easy and rapid change of the sealing plate
- Equipped with "gas flushing" (the universal sealing plate can not be used)

### CARACTERISTIQUES

- Thermoscelleuse semi-automatique électrique
- Construite en acier inox
- Plaque en aluminium teflonée
- Contrôle électronique de la température de la plaque (0-200°C)
- Cycle de soudure automatique
- Changement de la plaque de chauffe facile et rapide
- Équipée du système "gas flushing" (l'utilisation de la plaque de chauffe universelle n'est pas possible)

Mod.

## E-SG 420 GF



### MERKMALE

- Halbautomatisches und elektrisches Thermo-Schweißgerät
- Aus Edelstahl gebaut
- Platte aus Teflon-beschichtetem Aluminium
- Elektronische Temperaturregelung der Platte (0-200° C)
- Automatischer Schweiß-Zyklus
- Leichter und schneller Austausch der Schweißplatte
- "Gas-Spülung" (Anwendung der universalen Schweißplatte nicht möglich)

### CARACTERÍSTICAS

- Termoselladora semiautomática eléctrica
- Construida en acero inox
- Plancha de aluminio teflonada
- Control electrónico de la temperatura de la plancha (0-200°C)
- Ciclo de soldadura automático
- Sustitución fácil y rápida de la plancha soldadora
- Equipada de inyección de gas con sistema "gas flushing" (no se puede utilizar la plancha soldadora universal)

# E-SG 260

## Optionals



- Stampo singola impronta per vaschette 140x195 mm
- Die single impression for trays 140x195 mm
- Outillage à empreinte unique pour barquettes 140x195 mm
- Werkzeug einfache Aufnahme für Schalen 140x195 mm
- Molde para el sellado de una bandeja 140x195 mm



- Stampo doppia impronta per vaschette 95x140 mm x 2
- Die double impression for trays 95x140 mm x 2
- Outillage à double empreinte pour barquettes 95x140 mm x 2
- Werkzeug doppelte Aufnahme für Schalen 95x140 mm x 2
- Molde para el sellado de dos bandejas 95x140 mm x 2



- Stampo singola impronta per piatto 180x180 mm
- Die single impression for tray 180x180 mm
- Outillage à empreinte unique pour barquettes 180x180 mm
- Werkzeug einfache Aufnahme für Teller 180x180 mm
- Molde para el sellado de un plato 180x180 mm



- Stampo singola impronta per vaschette GN ¼ (160x260 mm)
- Die single impression for trays GN ¼ (160x260 mm)
- Outillage à empreinte unique pour barquettes GN ¼ (160x260 mm)
- Werkzeug einfache Aufnahme für Schalen GN ¼ (160x260 mm)
- Molde para el sellado de una bandeja GN ¼ (160x260 mm)

- A richiesta si possono avere impronte di varie forme e dimensioni
- On request it is possible to get dies of different forms and sizes
- Sur demande il est possible d'avoir des empreintes de formes et dimensions diverses
- Auf Anfrage sind Werkzeuge von verschiedenen Formen und Größen erhältlich
- Bajo petición se pueden tener bandejas de diferentes formas y tamaños

# Optionals



- Piastra saldante con fustellatura + stampo singola impronta per piatto 180x180 mm
- Sealing plate with profile cut and die single impression for tray 180x180 mm
- Plaque de chauffe avec coupe aux contours + outillage à empreinte unique pour barquette 180x180mm
- Schweißplatte mit Schneidevorrichtung + Werkzeug einfache Aufnahme für Teller 180x180 mm
- Plancha soldadora con recorte perimetral + molde para el sellado de un plato 180x180 mm



- Piastra saldante con fustellatura + stampo singola impronta per vaschette 227x178 mm
- Sealing plate with profile cut and die single impression for trays 227x178 mm
- Plaque de chauffe avec coupe aux contours + outillage à empreinte unique pour barquettes 227x178 mm
- Schweißplatte mit Schneidevorrichtung + Werkzeug einfache Aufnahme für Schalen 227x178 mm
- Plancha soldadora con recorte perimetral + molde para el sellado de una bandeja 227x178 mm

- A richiesta è possibile avere la fustellatura di stampi speciali
- Customized profile cut for dies available on request
- Sur demande il est possible d'avoir des coupes aux contours d'outillages spécifiques
- Auf Anfrage wird die Folien-Schneidevorrichtung für kundenspezifische Werkzeuge angefertigt
- Bajo petición se puede tener el recorte perimetral de moldes especiales

# E-SG 420

## Optionals



- Stampo doppia impronta per piatto  
180x180 mm x 2
- Die double impression for standard tray  
180x180 mm x 2
- Outillage à double empreinte pour barquettes  
180x180 mm x 2
- Werkzeug doppelte Aufnahme für Teller  
180x180 mm x 2
- Molde para el sellado de dos platos  
180x180 mm x 2



- Stampo 4 impronte per vaschette  
140x195 mm x 4
- Die 4 impression for trays  
140x195 mm x 4
- Outillage 4 empreintes pour barquettes  
140x195 mm x 4
- Werkzeug 4 Aufnahmen für Schalen  
140x195 mm x 4
- Molde para el sellado de 4 bandejas  
140x195 mm x 4



- Stampo 8 impronte per vaschette  
95x140 mm x 8
- Die 8 impression for trays  
95x140 mm x 8
- Outillage 8 empreintes pour barquettes  
95x140 mm x 8
- Werkzeug 8 Aufnahmen für Schalen  
95x140 mm x 8
- Molde para el sellado de 8 bandejas  
95x140 mm x 8



- Stampo doppia impronta per vaschette  
GN ¼ x 2 (160x260 mm x 2)
- Die double impression for trays  
GN ¼ x 2 (160x260 mm x 2)
- Outillage à double empreinte pour barquettes  
GN ¼ x 2 (160x260 mm x 2)
- Werkzeug doppelte Aufnahme für Schalen  
GN ¼ x 2 (160x260 mm x 2)
- Molde para el sellado de dos bandejas  
GN ¼ x 2 (160x260 mm x 2)



- Stampo singola impronta per vaschette  
GN ½ (260x315 mm)
- Die single impression for trays  
GN ½ (260x315 mm)
- Outillage à empreinte unique pour barquettes  
GN ½ (260x315 mm)
- Werkzeug einfache Aufnahme für Schalen  
GN ½ (260x315 mm)
- Molde para el sellado de una bandeja  
GN ½ (260x315 mm)

- A richiesta si possono avere impronte di varie forme e dimensioni
- On request it is possible to get dies of different forms and sizes
- Sur demande il est possible d'avoir des empreintes de formes et dimensions diverses
- Auf Anfrage sind Werkzeuge von verschiedenen Formen und Größen erhältlich
- Bajo petición se pueden tener bandejas de diferentes formas y tamaños











- Piastra saldante con fustellatura + stampo doppia impronta per piatto 180x180 mm x 2
- Sealing plate with profile cut and die double impression for tray 180x180 mm x 2
- Plaque de chauffe avec coupe aux contours + outillage à double empreinte pour barquette 180x180mm x 2
- Schweißplatte mit Schneidevorrichtung + Werkzeug doppelte Aufnahme für Teller 180x180 mm x 2
- Plancha soldadora con recorte perimetral + molde para el sellado de dos platos 180x180 mm x 2



- A richiesta è possibile avere la fustellatura di stampi speciali
- Customized profile cut for dies available on request
- Sur demande il est possible d'avoir des coupes aux contours d'outillages spécifiques
- Auf Anfrage wird die Folien-Schneidevorrichtung für kundenspezifische Werkzeuge angefertigt
- Bajo petición se puede tener el recorte perimetral de moldes especiales
- Dispositivo taglio film longitudinale
- Film cutting device
- Dispositif découpe film longitudinale
- Folien Längsschnitt
- Dispositivo de corte film longitudinal

# E-SG 260

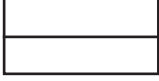
## CONFIGURAZIONE STAMPI - MOULDS CONFIGURATION - CONFIGURATION DES MOULES KONFIGURATION DER NUETZEN - CONFIGURACIÓN MOLDES

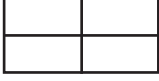
Impronte Impressions Empreintes Nutzen Improntas	Senza fustellatura Without profile cut Sans coupe autour Ohne Konturschneidung Sin recorte perimetral	Con fustellatura With profile cut Avec coupe autour Mit Konturschneidung Con recorte perimetral
1	 260 x 200 mm	 230 x 180 mm
	 Ø 200 mm	 Ø 180 mm
2	 200 x 125 mm	 100 x 180 mm
	 95 x 260 mm	
	 Ø 130 mm	 Ø 100 mm
4	 120 x 95 mm	

### IMPORTANTE

- L'altezza massima possibile delle vaschette è di 115 mm
- Tutte le grandezze sono indicate in mm (millimetri) e sono intese come dimensioni massime possibili
- Ogni tipo di stampo può essere confermato solo dopo la visione di una campionatura di vaschette
- Ulteriori tipi di stampi sono possibili su richiesta

### IMPORTANT

- The maximal height of the trays can be 115 mm
- All sizes are indicated in mm (millimetres) and are intended as maximum sizes possible
- Each type of mould can be confirmed only after having received some samples of trays
- Additional types of moulds are available on request

### ATTENTION

- La hauteur maximale des barquettes peut être de 115 mm
- Toutes les dimensions sont indiqués en mm (millimètres) et ce sont les tailles maximales possibles
- Chaque type de moule peut être confirmé seulement après avoir reçu les échantillons
- D'autres types de moules sont disponibles sur demande

### ZU BEACHTEN

- Maximale Höhe der Schalen ist 115 mm
- Alle Größen sind in mm (Millimeter) angegeben und sind die maximalen möglichen Größen
- Jede Art von Nutzen kann erst nach Betrachten des Ausfallmusters der Schalen bestätigt werden
- Andere Nutzen sind auf Anfrage erhältlich

### IMPORTANTE

- La altura máxima posible de las bandejas es 115 mm
- Todas las dimensiones están indicadas en mm (milímetros) y se consideran dimensiones máximas posibles
- Cada tipo de molde se puede confirmar solo después de la visión de un muestreo de bandejas
- Otros tipos de moldes están disponibles bajo petición



## TECHNICAL INFO

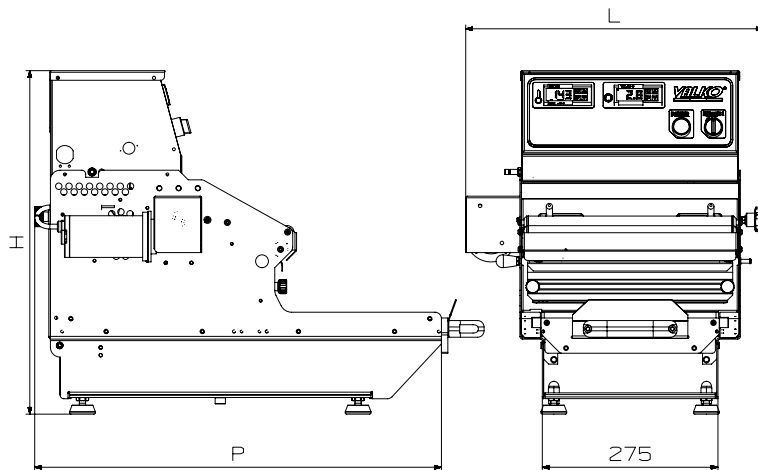









Modello Model Modèle Modell Modelo	Larghezza Width Larguer Breite Anchura	Profondità Depth Profondeur Tiefe Profundidad	Altezza Height Hauteur Höhe Altura	Stampo / Die / Moule / Formenabdruck / Molde			Altezza max. vaschette Max. height of the cup Hauteur max. barquette Max. Höhe der Schale Altura máx. bandejas	Bobina / Roll Bobine / Rolle / Bobina		Tensione Voltage Tension Spannung Voltaje	Potenza Power Puissance Leistung Potencia	Peso Weight Poids Gewicht Peso
				Singola impronta Single impression Simple empreinte Einfache Aufnahme Una bandeja	Doppia impronta Double impression Double empreinte Doppelte Aufnahme Dos bandejas	Impronta max. Max. impression Empreinte max. Max. Aufnahme Impronta máx.		Larghezza Width Larguer Breite Anchura	Ø max. Max. Ø Ø max. Max. Ø Ø máx.			
<b>E-SG 260</b>	465 mm	635 mm	535 mm	¼ GN (160x260 mm)	n°. 2 x 140x95 mm	260x200 mm	115 mm	260 mm	210 mm	230V~	750 W	Kg 33

Modello Model Modèle Modell Modelo	Larghezza Width Larguer Breite Anchura	Profondità Depth Profondeur Tiefe Profundidad	Altezza Height Hauteur Höhe Altura	Impronta max. Max. impression Empreinte max. Max. Aufnahme Impronta máx.	Altezza max. vaschette Max. height of the cup Hauteur max. barquette Max. Höhe der Schale Altura máx. bandejas	Bobina / Roll Bobine / Rolle / Bobina		Tensione Voltage Tension Spannung Voltaje	Potenza Power Puissance Leistung Potencia	Peso Weight Poids Gewicht Peso
						Larghezza Width Larguer Breite Anchura	Ø max. Max. Ø Ø max. Max. Ø Ø máx.			
<b>E-SG 260 GF</b>	465 mm	635 mm	535 mm	230x180 mm	115 mm	260 mm	210 mm	230V~	750 W	Kg 36

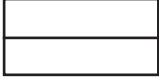
# E-SG 420

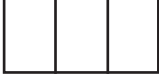
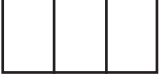
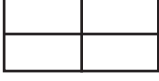
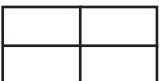
## CONFIGURAZIONE STAMPI - MOULDS CONFIGURATION - CONFIGURATION DES MOULES KONFIGURATION DER NUETZEN - CONFIGURACIÓN MOLDES

Impronte Impressions Empreintes Nutzen Improntas	Senza fustellatura Without profile cut Sans coupe autour Ohne Konturschneidung Sin recorte perimetral	Con fustellatura With profile cut Avec coupe autour Mit Konturschneidung Con recorte perimetral
1	 295 x 420 mm	 275 x 380 mm
	 Ø 295 mm	
2	 295 x 205 mm	 275 x 175 mm
	 138 x 400 mm	
	 Ø 200 mm	
3	 130 x 295 mm	 275 x 112 mm
4	 205 x 145 mm	 130 x 175 mm
	 98 x 295 mm	

### IMPORTANTE

- L'altezza massima possibile delle vaschette è di 150 mm
- Tutte le grandezze sono indicate in mm (millimetri) e sono intese come dimensioni massime possibili
- Ogni tipo di stampo può essere confermato solo dopo la visione di una campionatura di vaschette
- Ulteriori tipi di stampi sono possibili su richiesta

### IMPORTANT

- The maximal height of the trays can be 150 mm
- All sizes are indicated in mm (millimetres) and are intended as maximum sizes possible
- Each type of mould can be confirmed only after having received some samples of trays
- Additional types of moulds are available on request

### ATTENTION

- La hauteur maximale des barquettes peut être de 150 mm
- Toutes les dimensions sont indiqués en mm (millimètres) et ce sont les tailles maximales possibles
- Chaque type de moule peut être confirmé seulement après avoir reçu les échantillons
- D'autres types de moules sont disponibles sur demande

### ZU BEACHTEN

- Maximale Höhe der Schalen ist 150 mm
- Alle Größen sind in mm (Millimeter) angegeben und sind die maximalen möglichen Größen
- Jede Art von Nutzen kann erst nach Betrachten des Ausfallmusters der Schalen bestätigt werden
- Andere Nutzen sind auf Anfrage erhältlich

### IMPORTANTE

- La altura máxima posible de las bandejas es 150 mm
- Todas las dimensiones están indicadas en mm (milímetros) y se consideran dimensiones máximas posibles
- Cada tipo de molde se puede confirmar solo después de la visión de un muestreo de bandejas
- Otros tipos de moldes están disponibles bajo petición

## TECHNICAL INFO

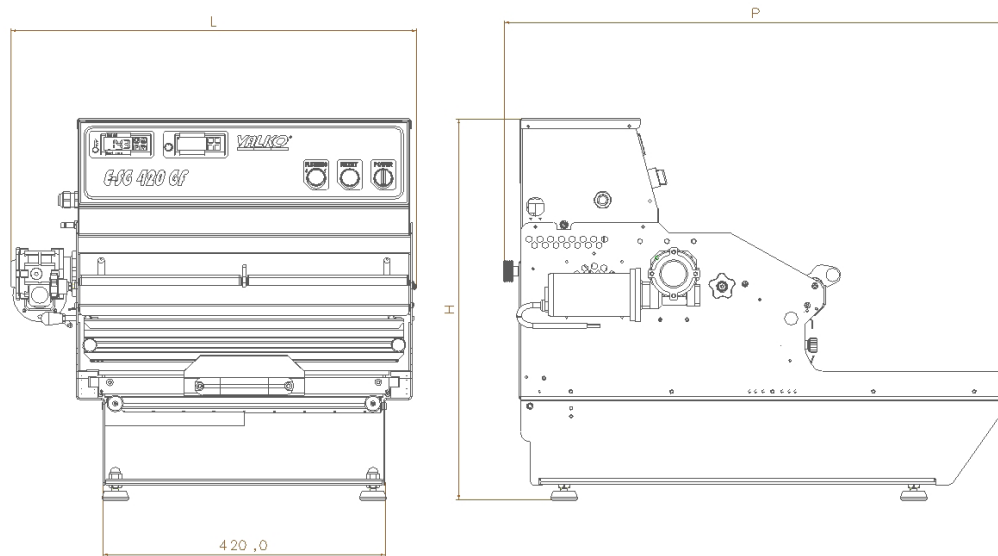

Modello Model Modèle Modell Modelo	Larghezza Width Larguer Breite Anchura	Profondità Depth Profondeur Tiefe Profundidad	Altezza Height Hauteur Höhe Altura	Impronta max. Max. impression Empreinte max. Max. Aufnahme Impronta máx.	Altezza max. vaschette Max. height of the cup Hauteur max. barquette Max. Höhe der Schale Altura máx. bandejas	Bobina / Roll Bobine / Rolle / Bobina		Tensione Voltage Tension Spannung Voltaje	Potenza Power Puissance Leistung Potencia	Peso Weight Poids Gewicht Peso
						Larghezza Width Larguer Breite Anchura	ø max. Max. ø ø max. Max. ø ø máx.			
<b>E-SG 420</b>	650 mm	750 mm	570 mm	295x420 mm	150 mm	420 mm	220 mm	230V~	1350 W	Kg 53

Modello Model Modèle Modell Modelo	Larghezza Width Larguer Breite Anchura	Profondità Depth Profondeur Tiefe Profundidad	Altezza Height Hauteur Höhe Altura	Impronta max. Max. impression Empreinte max. Max. Aufnahme Impronta máx.	Altezza max. vaschette Max. height of the cup Hauteur max. barquette Max. Höhe der Schale Altura máx. bandejas	Bobina / Roll Bobine / Rolle / Bobina		Tensione Voltage Tension Spannung Voltaje	Potenza Power Puissance Leistung Potencia	Peso Weight Poids Gewicht Peso
						Larghezza Width Larguer Breite Anchura	ø max. Max. ø ø max. Max. ø ø máx.			
<b>E-SG 420 GF</b>	650 mm	750 mm	570 mm	275x380 mm	150 mm	420 mm	220 mm	230V~	1350 W	Kg 57



**VALKO** srl  
Via Berlino, 1  
24040 Bottanuco  
(Bergamo) Italy

**Phone**  
+39.035.4992010  
**Fax**  
+39.035.4992015

[www.valko.com](http://www.valko.com)  
[info@valko.com](mailto:info@valko.com)

Made in Italy



Le fotografie rappresentate contengono optional.  
Pictures with accessories.  
Les photos représentées sont avec des options.  
Photos mit Zubehören.  
Las fotografías muestran los opcionales.

La ditta VALKO si riserva il diritto di apportare qualsiasi modifica per il miglioramento delle sue apparecchiature.  
VALKO reserves the right to change its equipment in order to improve it.  
Document non contractuel. La VALKO pratique une politique d'amélioration permanente et se réserve le droit de modifier ses appareils sans notification préalable.  
Änderungen für Verbesserungen vorbehalten.  
La empresa VALKO se reserva el derecho de realizar modificaciones para mejorar sus aparatos.